



100394000

Onsite Septic System Application

Becker County Planning & Zoning
915 Lake Ave, Detroit Lakes, MN 56501
Phone (218)-846-7314; Fax (218)-846-7266

PARCEL	
APP	SEPTIC
YEAR	
SCANNED	
LAKE	

1. PROPERTY DATA (as it appears on the tax statement, purchase agreement or deed)

Parcel Number(s) of property where the system will be installed: 100394000

Is this a split of an existing property? Yes No
(If yes and a parcel number has not yet been assigned, indicate the main parcel number from which the new parcel was split.)

Section 24 Township 139 Range 40 Township Name ERIE

Lake Name Wetles Lake Classification NE

Legal Description: N 16 Rds of E 20 Rds of SE 1/4 of SE 1/4

Project Address: 18178 350th Ave Detroit Lakes

2. PROPERTY OWNER INFORMATION (as it appears on the tax statement, purchase agreement or deed)

Owner's First Name RICHARD Owner's Last Name LECIVRE

Mailing Address 9750 Hall Ave NE City, State, Zip Monticello, MN 55362

Phone Number _____

3. DESIGNER/INSTALLER INFORMATION

Designer Name Randy Anderson Company Name Anderson On-site License # 634

Address P.O. 1421 Detroit Lakes Phone Number 848 3072

Installer Name Tony Stenger Company Name Tony Stenger Excavating License # 388

Address _____ Phone Number _____

4. SYSTEM DESIGN INFORMATION

System Status

What will new system serve? Check one

- Vacant Lot-No existing system-new structure
- Replacement - structure removed and being rebuilt
- Failing -Replacement- cesspool/seepage pit or other
- Enlargement of system-Undersized
- Repairs Needed to existing
- Additional system on property

- Dwelling
- Resort/Commercial
- Commercial (Non-resort)
- Other -- explain below

10/10/16 Date of site evaluation

Design Flow 450 Gallons Per Day
 Number of Bedrooms 2
 Garbage Disposal Yes No
 Dishwasher Yes No
 Lift station in House Yes No
 Grinder pump in House Yes No

Well Depth to be drilled
 Depth of other wells within 100 ft of system N/A

Original Soil Compacted Soil
 Type of Soil Observation
 Pit Boring
 Depth to Restricting Layer 18
 Maximum Depth of System mobile

Size of All Tanks to be installed

- gal Single Compartment Septic Tank
- gal Compartmented Tank
- Pit Privy
- gal Separate Lift Station
- gal Holding Tank
- Existing Tank to be used

- Existing tank w/new Additional Tank
- Existing tank w/new Lift Station
- Holding Tank with Privy

Total Number of tanks to be installed in this system 1 (This # will be reported to MPCOA at end of year.)

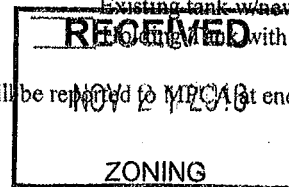

PARCEL	APP	YEAR
	SEPTIC	

Type of Drainfield
 Chamber Trench
 Rock Trench
 Gravelless
 Mound
 Pressure Bed
 Sepage Bed
 At-grade
 Alternative /
 Performance

Full Size of Drainfield sq ft
 Reduced/Warranted size sq ft
 Attach Worksheets *** sq ft ***

Type of chamber
 Depth of Rock
 Alarm? Yes K No
 Type of Alarm elec
 Size of Lift Pump 29 gpm 14 hrs
 Size of Lift Line 2"

PROPOSED SETBACKS
 TANK
 DRAINFIELD
 Distance to Well to be installed
 Distance to Building
 Distance to Property Line
 Distance to OHW of Lake
 Distance to Pressure Line
 Distance to Wetland/Protected Water

Per Rate 20 Soil Sizing Factor 16 *If SSF other than .83, attach Perc Test Data

Soil Borings (three are required)	Depth	Texture	Color	Structure	Depth	Texture	Color	Structure
B-6	0-5'	loam	10YR2/1	loam	0-5'	loam	10YR2/1	loam
B-20	6-18	fine sand	10YR2/3	single	6-18	fine sand	10YR2/3	single
B-18	18+	loam	10YR2/4	blocky	18+	loam	10YR2/4	blocky
B-18	18+	Reddy			18+	Reddy		

5. REQUIRED DOCUMENTS

U of MN worksheets are required for mounds, pressure beds, seepage beds, at-grades or Type IV or Type V systems. Are the required worksheets attached? Yes No

6. DESIGNER'S CERTIFIED STATEMENT

I, Kendy Johnson certify that I have completed the preceding design work in accordance with all applicable requirements (including, but not limited to Minnesota Chapter 7080 and the Becker County Individual Sewage Treatment System Ordinance).

Signature of Designer

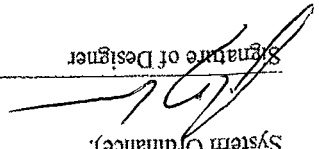

Date

12/6/16

100394000
18178 350th Ave

↓
↓
1" = 30'

350th Ave RW

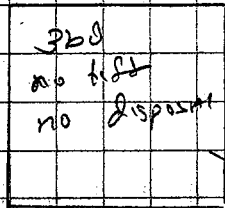

Fall 2016
Tank only



x 50

1600 gpm Septic
500 gpm lift



to be installed
2017

Done

6/21/17

lot line
20' ±

2 Ac
lot lines need to be
verified by Home owner

WOODED
Area

↓
lot line
20' ±



OSTP Design Summary Worksheet



Property Owner/Client: Project ID: v 05.13.14
 Site Address: Date:

1. DESIGN FLOW AND TANKS

A. Design Flow: Gallons Per Day (GPD) *Note: The estimated design flow is considered a peak flow rate including a safety factor. For long term performance, the average daily flow is recommended to be < 60% of this value.*

B. Septic Tanks:

Minimum Code Required Septic Tank Capacity: Gallons, in Tanks or Compartments

Recommended Septic Tank Capacity: Gallons, in Tanks or Compartments

Effluent Screen: Alarm:

C. Holding Tanks Only:

Minimum Code Required Capacity: Gallons, in Tanks

Designer Recommended Capacity: Gallons, in Tanks

Type of High Level Alarm:

D. Pump Tank 1 Capacity (Code Minimum): Gallons Pump Tank 2 Capacity (Code Minimum): Gallons

Pump Tank 1 Capacity (Designer Rec): Gallons Pump Tank 2 Capacity (Designer Rec): Gallons

Pump 1 GPM Total Head ft Pump 2 GPM Total Head ft

Supply Pipe Dia. in Dose Volume: gal Supply Pipe Dia. in Dose Volume: gal

2. SYSTEM TYPE

- Trench Bed Mound At-Grade Gravity Distribution Pressure Distribution-Level Pressure Distribution-Unlevel
 Drip Holding Tank Other * Selection Required

Benchmark Elevation: ft

Benchmark Location:

System Type

- Type I Type II Type III Type IV Type V

Type of Distribution Media:

- Drainfield Rock Registered Treatment Media:

3. SITE EVALUATION:

A. Depth to Limiting Layer: in ft

B. Measured Land Slope %: %

C. Elevation of Limiting Layer:

D. Soil Texture:

E. Loc. of Restrictive Elevation:

F. Soil Hyd. Loading Rate: GPD/ft²

G. Minimum Required Separation: in ft

H. Perc Rate: MPI

I. Code Maximum Depth of System: in Comments:

4. DESIGN SUMMARY

Trench Design Summary

Dispersal Area ft² Sidewall Depth in Trench Width ft

Total Lineal Feet ft Number of Trenches Code Maximum Trench Depth in

Contour Loading Rate ft Designer's Max Trench Depth in

Bed Design Summary

Absorption Area ft² Depth of sidewall in Code Maximum Bed Depth in

Bed Width ft Bed Length ft Designer's Max Bed Depth in



Mound Design Summary					
Absorption Bed Area	<input type="text" value="380.0"/>	ft ²	Bed Length	<input type="text" value="38.0"/>	ft
Absorption Width	<input type="text" value="20.0"/>	ft	Clean Sand Lift	<input type="text" value="1.5"/>	ft
Upslope Berm Width	<input type="text" value="14.0"/>	ft	Downslope Berm Width	<input type="text" value="14.0"/>	ft
Total System Length	<input type="text" value="66.0"/>	ft	Total System Width	<input type="text" value="38.0"/>	ft
			Bed Width	<input type="text" value="10.0"/>	ft
			Berm Width (0-1%)	<input type="text" value="14.0"/>	ft
			Endslope Berm Width	<input type="text" value="14.0"/>	ft
			Contour Loading Rate	<input type="text" value="12.0"/>	gal/ft

At-Grade Design Summary					
Absorption Bed Width	<input type="text"/>	ft	Absorption Bed Length	<input type="text"/>	ft
Contour Loading Rate	<input type="text"/>	gal/ft	Upslope Berm Width	<input type="text"/>	ft
Endslope Berm Width	<input type="text"/>	ft	System Length	<input type="text"/>	ft
			System Height	<input type="text"/>	ft
			Downslope Berm Width	<input type="text"/>	ft
			System Width	<input type="text"/>	ft

Level & Equal Pressure Distribution Summary					
No. of Perforated Laterals	<input type="text" value="3"/>		Perforation Spacing	<input type="text" value="3"/>	ft
Lateral Diameter	<input type="text" value="2.00"/>	in	Min. Delivered Volume	<input type="text" value="73"/>	gal
			Perforation Diameter	<input type="text" value="1/4"/>	in
			Maximum Delivered Volume	<input type="text" value="113"/>	gal

Non-Level and Unequal Pressure Distribution Summary							
	Elevation (ft)	Pipe Size (in)	Pipe Volume (gal/ft)	Pipe Length (ft)	Perforation Size (in)	Spacing (ft)	Spacing (in)
Lateral 1							
Lateral 2							
Lateral 3							
Lateral 4							
Lateral 5							
Lateral 6							

Minimum Delivered Volume gal

Maximum Delivered Volume gal

5. Additional Info for Type IV/Pretreatment Design

A. Calculate the organic loading

1. Organic Loading to Pretreatment Unit = Design Flow X Estimated BOD in mg/L in the effluent X 8.35 ÷ 1,000,000

gpd X mg/L X 8.35 ÷ 1,000,000 = lbs BOD/day

2. Type of Pretreatment Unit Being Installed:

3. Calculate Soil Treatment System Organic Loading: BOD concentration after pretreatment ÷ Bottom Area = lbs/day/ft²

mg/L X 8.35 ÷ 1,000,000 ÷ ft² = lbs/day/ft²

Comments/Special Design Considerations:

I hereby certify that I have completed this work in accordance with all applicable ordinances, rules and laws.

Randy Anderson
(Designer)



(Signature)

634
(License #)

10/06/16
(Date)



OSTP Mound Design Worksheet <1% Slope



1. SYSTEM SIZING: Project ID: v 05.13.14

- A. Design Flow : GPD
- B. Soil Loading Rate: GPD/ft²
- C. Depth to Limiting Condition: ft
- D. Percent Land Slope: %
- E. Design Media Loading Rate: GPD/ft²
- F. Mound Absorption Ratio:

TABLE IXa				
LOADING RATES FOR DETERMINING BOTTOM ABSORPTION AREA AND ABSORPTION RATIOS USING PERCOLATION TESTS				
Percolation Rate (MPI)	Treatment Level C		Treatment Level A, A-2, B	
	Absorption Area Loading Rate (gpd/ft ²)	Mound Absorption Ratio	Absorption Area Loading Rate (gpd/ft ²)	Mound Absorption Ratio
<0.1	-	1	-	1
0.1 to 5	1.2	1	1.6	1
0.1 to 5 (fine sand and loamy fine sand)	0.6	2	1	1.6
6 to 15	0.78	1.5	1	1.8
16 to 30	0.6	2	0.78	2
31 to 45	0.5	2.4	0.78	2
46 to 60	0.45	2.6	0.6	2.6
61 to 120	-	5	0.3	5.3
>120	-	-	-	-

Table I			
MOUND CONTOUR LOADING RATES:			
Measured Perc Rate	OR	Texture - derived mound absorption ratio	Contour Loading Rate:
≤ 60mpi		1.0, 1.3, 2.0, 2.4, 2.6	→ ≤12
61-120 mpi	OR	5.0	→ ≤12
≥ 120 mpi*		>5.0*	→ ≤6*

*Systems with these values are not Type I systems. Contour Loading Rate (linear loading rate) is a recommended value.

2. DISPERSAL MEDIA SIZING

A. Calculate Dispersal Bed Area: Design Flow (1.A) ÷ Design Media Loading Rate (1.E) = ft²

GPD ÷ GPD/ft² = ft²

If a larger dispersal media area is desired, enter size: ft²

B. Enter Dispersal Bed Width: ft *Can not exceed 10 feet.*

C. Calculate Contour Loading Rate: Bed Width (2.B) X Design Media Loading Rate (1.E)

ft² X GPD/ft² = gal/ft *Can not exceed Table 1*

D. Calculate Minimum Dispersal Bed Length: Dispersal Bed Area (2.A) ÷ Bed Width (2.B) = Bed Length

ft² ÷ ft = ft

3. ABSORPTION AREA SIZING

A. Calculate Absorption Width: Bed Width (2.B) X Mound Absorption Ratio (1.F) = Absorption Width

ft X = ft

B. For slopes from 0 to 1%, the Absorption Width is measured from the bed equally in both directions.

Absorption Width Beyond the Bed: Absorption Width (3.A) - Bed Width (2.B) ÷ 2 = Width beyond Bed

(ft - ft) ÷ 2 = ft

4. DISTRIBUTION MEDIA: ROCK

A. Media Volume: Media Depth below and above pipe X Length X Width

$$1.00 \text{ ft} \times 38.0 \text{ ft} \times 10.0 \text{ ft} = 380 \text{ ft}^3 \div 27 = 14.1 \text{ yd}^3$$

5. DISTRIBUTION MEDIA: REGISTERED TREATMENT PRODUCTS: CHAMBERS AND EZFLOWA. Enter Dispersal Media: B. Enter the Component: Length: ft Width: ft Depth: ft

C. Number of Components per Row = Bed Length divided by Component Length (Round up)

$$\text{[] ft} \div \text{[] ft} = \text{[] components/row}$$

D. Actual Bed Length = Number of Components/row X Component Length:

$$\text{[] components} \times \text{[] ft} = \text{[] ft}$$

E. Number of Rows = Bed Width divided by Component Width

$$\text{[] ft} \div \text{[] ft} = \text{[] rows} \text{ Adjust width so this is a whole number.}$$

F. Total Number of Components = Number of Components per Row X Number of Rows

$$\text{[]} \times \text{[]} = \text{[] components}$$

6. MOUND SIZING

A. Calculate Clean Sand Lift: 3 feet minus Depth to Limiting Condition = Clean Sand Lift (1 ft minimum)

$$3.0 \text{ ft} - 1.5 \text{ ft} = 1.5 \text{ ft} \quad \text{Design Sand Lift (optional): [] ft}$$

B. Upslope Mound Height = Clean Sand Lift + Depth of Media + Depth of Cover (1 ft)

$$1.5 \text{ ft} + 1.00 \text{ ft} + 1.0 \text{ ft} = 3.5 \text{ ft}$$

C. Berm Width = Upslope Mound Height (4.B) X 4 (4 is recommended, but could be 3-12)

$$3.5 \text{ ft} \times 4.0 \text{ ft} = 14.0 \text{ ft}$$

D. Total Landscape Width = Berm Width + Dispersal Bed Width + Berm Width

$$14.0 \text{ ft} + 10.0 \text{ ft} + 14.0 \text{ ft} = 38.0 \text{ ft}$$

E. Additional Berm Width necessary for absorption - Absorption Width - Total Landscape Width

$$20.0 \text{ ft} - 38.0 \text{ ft} = 0 \text{ ft} \quad \text{if number is negative (<0), value is ZERO}$$

F. Final Berm Width = Additional Berm Width + Berm Width

$$0 \text{ ft} + 14.0 \text{ ft} = 14.0 \text{ ft}$$

G. Total Mound Width = Final Berm Width + Dispersal Bed Width + Final Berm Width

$$14.0 \text{ ft} + 10.0 \text{ ft} + 14.0 \text{ ft} = 38.0 \text{ ft}$$

H. Total Mound Length = Final Berm Width + Dispersal Bed Length + Final Berm Width

$$14.0 \text{ ft} + 38.0 \text{ ft} + 14.0 \text{ ft} = 66.0 \text{ ft}$$

I. Setbacks from the Bed: Absorption Width - Dispersal Bed Width divided by 2

$$(\text{[] ft} - \text{[]}) / 2 = \text{[] ft}$$

7. MOUND DIMENSIONS

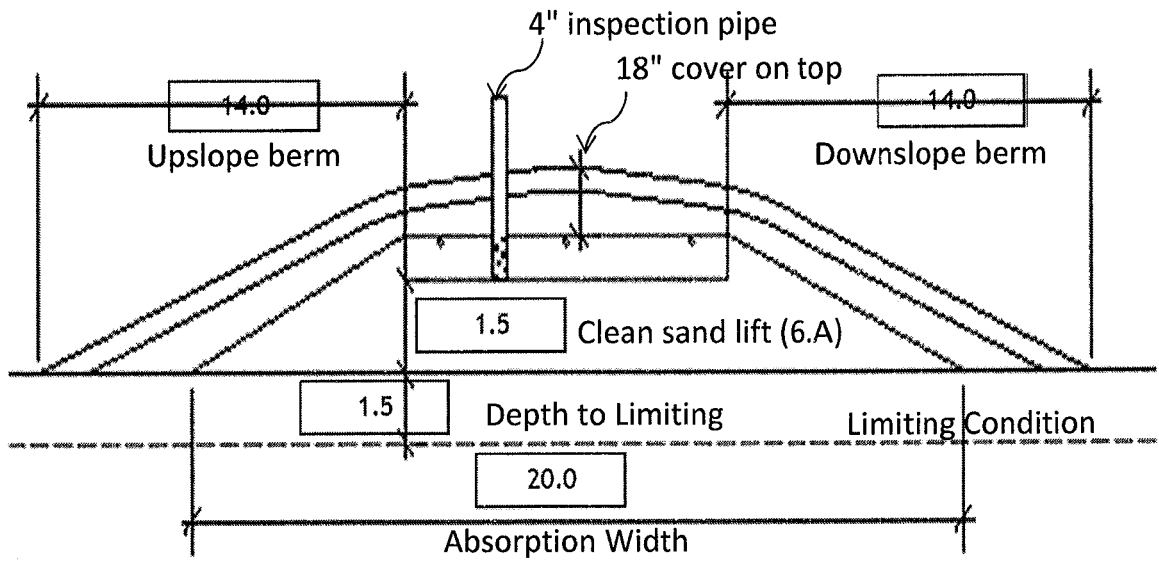
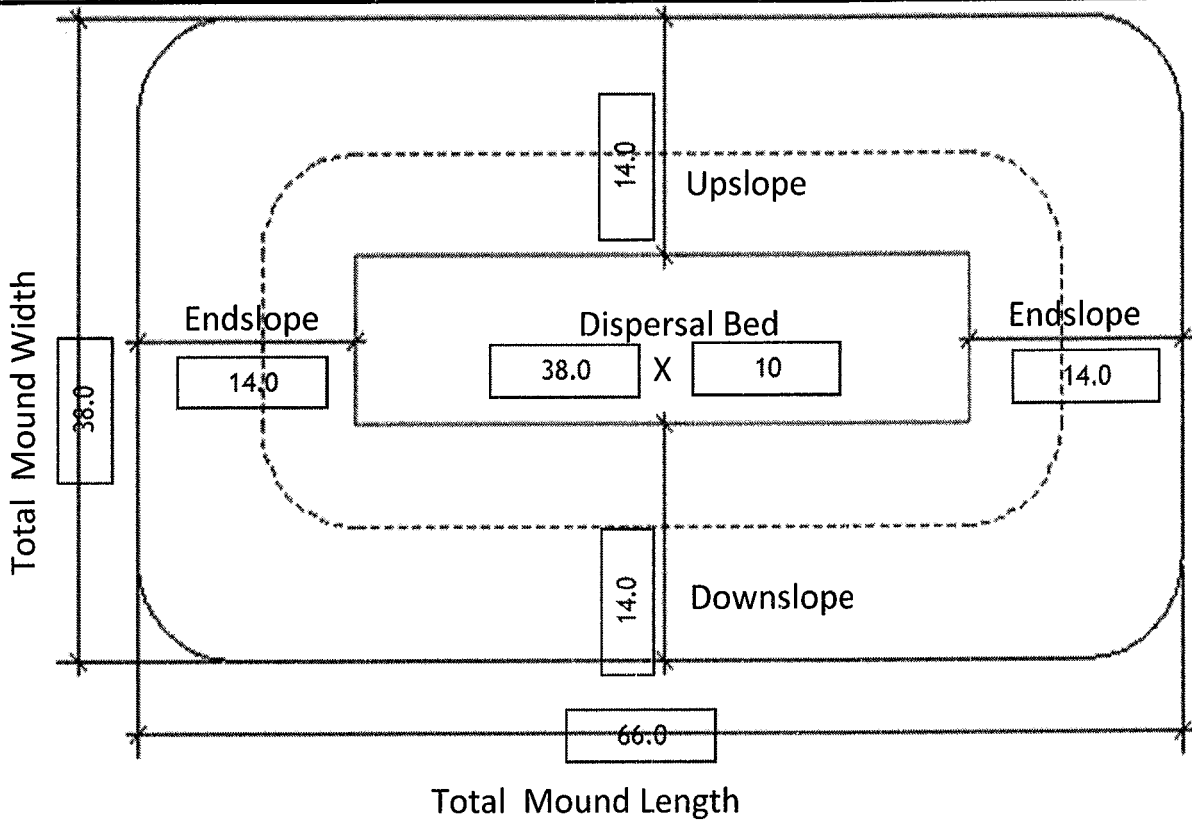

Comments:



OSTP Mound Materials Worksheet



Project ID:

v 05.13.14

A. Calculate Bed (rock) Volume: Bed Length (2.C) X Bed Width (2.B) X Depth = Volume (ft³)

$$\boxed{38.0} \text{ ft} \times \boxed{10.0} \text{ ft} \times 1.0 = \boxed{380.0} \text{ ft}^3$$

Divide ft³ by 27 ft³/yd³ to calculate cubic yards:

$$\boxed{380.0} \text{ ft}^3 \div 27 = \boxed{14.1} \text{ yd}^3$$

Add 20% for constructability:

$$\boxed{14.1} \text{ yd}^3 \times 1.2 = \boxed{16.9} \text{ yd}^3$$

B. Calculate Clean Sand Volume:

Volume Under Rock bed: Average Sand Depth x Media Width x Media Length = cubic feet

$$\boxed{1.5} \text{ ft} \times \boxed{10.0} \text{ ft} \times \boxed{38.0} \text{ ft} = \boxed{570.0} \text{ ft}^3$$

For a Mound on a slope from 0-1%

Volume from Length = ((Upslope Mound Height - 1) X Absorption Width Beyond Bed X Media Bed Length)

$$\boxed{3.50} \text{ ft} - 1) \times \boxed{5.00} \times \boxed{38} \text{ ft} = \boxed{475.00}$$

Volume from Width = ((Upslope Mound Height - 1) X Absorption Width Beyond Bed X Media Bed Width)

$$\boxed{3.50} \text{ ft} - 1) \times \boxed{5.00} \times \boxed{10} \text{ ft} = \boxed{125.00}$$

Total Clean Sand Volume: Volume from Length + Volume from Width + Volume Under Media

$$\boxed{475.0} \text{ ft}^3 + \boxed{125.0} \text{ ft}^3 + \boxed{570} \text{ ft}^3 = \boxed{1170.0} \text{ ft}^3$$

For a Mound on a slope greater than 1%

Upslope Volume: (((Upslope Mound Height - 1) x 3 x Bed Length) + 2 = cubic feet

$$((\boxed{} \text{ ft} - 1) \times 3.0 \text{ ft} \times \boxed{}) + 2 = \boxed{} \text{ ft}^3$$

Downslope Volume: ((Downslope Height - 1) x Downslope Absorption Width x Media Length) + 2 = cubic feet

$$((\boxed{} \text{ ft} - 1) \times \boxed{} \text{ ft} \times \boxed{}) + 2 = \boxed{} \text{ ft}^3$$

Endslope Volume: (Downslope Mound Height - 1) x 3 x Media Width = cubic feet

$$(\boxed{} \text{ ft} - 1) \times 3.0 \text{ ft} \times \boxed{} \text{ ft} = \boxed{} \text{ ft}^3$$

Total Clean Sand Volume: Upslope Volume + Downslope Volume + Endslope Volume + Volume Under Media

$$\boxed{} \text{ ft}^3 + \boxed{} \text{ ft}^3 + \boxed{} \text{ ft}^3 + \boxed{} \text{ ft}^3 = \boxed{} \text{ ft}^3$$

Divide ft³ by 27 ft³/yd³ to calculate cubic yards:

$$\boxed{1170.0} \text{ ft}^3 \div 27 = \boxed{43.3} \text{ yd}^3$$

Add 20% for constructability:

$$\boxed{43.3} \text{ yd}^3 \times 1.2 = \boxed{52.0} \text{ yd}^3$$

C. Calculate Sandy Berm Volume:

Total Berm Volume (approx): ((Avg. Mound Height - 0.5 ft topsoil) x Mound Width x Mound Length) + 2 = cubic feet

$$(\boxed{3.5} - 0.5) \text{ ft} \times \boxed{38.0} \text{ ft} \times \boxed{66.0} + 2 = \boxed{3762.0} \text{ ft}^3$$

Total Mound Volume - Clean Sand volume - Rock Volume = cubic feet

$$\boxed{3762.0} \text{ ft}^3 - \boxed{1170.0} \text{ ft}^3 - \boxed{380.0} \text{ ft}^3 = \boxed{2212.0} \text{ ft}^3$$

Divide ft³ by 27 ft³/yd³ to calculate cubic yards:

$$\boxed{2212.0} \text{ ft}^3 \div 27 = \boxed{81.9} \text{ yd}^3$$

Add 20% for constructability:

$$\boxed{81.9} \text{ yd}^3 \times 1.2 = \boxed{98.3} \text{ yd}^3$$

D. Calculate Topsoil Material Volume: Total Mound Width X Total Mound Length X .5 ft

$$\boxed{38.0} \text{ ft} \times \boxed{66.0} \text{ ft} \times 0.5 \text{ ft} = \boxed{1254.0} \text{ ft}^3$$

Divide ft³ by 27 ft³/yd³ to calculate cubic yards:

$$\boxed{1254.0} \text{ ft}^3 \div 27 = \boxed{46.4} \text{ yd}^3$$

Add 20% for constructability:

$$\boxed{46.4} \text{ yd}^3 \times 1.2 = \boxed{55.7} \text{ yd}^3$$



OSTP Pressure Distribution Design Worksheet



Project ID:

v 05.13.14

1. Media Bed Width: ft

2. Minimum Number of Laterals in system/zone = Rounded up number of $[(\text{Media Bed Width} - 4) \div 3] + 1$.

$(\text{ } \boxed{10} \text{ } - 4) + 1 = \text{ } \boxed{3} \text{ } \text{laterals}$ *Does not apply to at-grades*

3. Designer Selected Number of Laterals: laterals

Cannot be less than line 2 (accept in at-grades)

4. Select Perforation Spacing: ft

5. Select Perforation Diameter Size: in

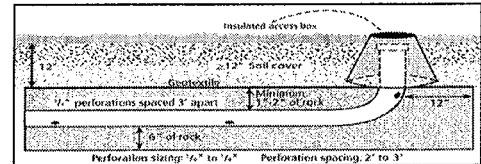

6. Length of Laterals = Media Bed Length - 2 Feet.

$\text{ } \boxed{38} \text{ } - 2\text{ft} = \text{ } \boxed{36} \text{ } \text{ft}$ *Perforation can not be closer than 1 foot from edge.*

7. Determine the Number of Perforation Spaces. Divide the Length of Laterals by the Perforation Spacing and round down to the nearest whole number.

$\text{Number of Perforation Spaces} = \text{ } \boxed{36} \text{ } \text{ft} \div \text{ } \boxed{3} \text{ } \text{ft} = \text{ } \boxed{12} \text{ } \text{Spaces}$

Number of Perforations per Lateral is equal to 1.0 plus the Number of Perforation Spaces. Check table

8. below to verify the number of perforations per lateral guarantees less than a 10% discharge variation. The value is double with a center manifold.

$\text{Perforations Per Lateral} = \text{ } \boxed{12} \text{ } \text{Spaces} + 1 = \text{ } \boxed{13} \text{ } \text{Perfs. Per Lateral}$

Maximum Number of Perforations Per Lateral to Guarantee < 10% Discharge Variation											
1/4 Inch Perforations						7/32 Inch Perforations					
Perforation Spacing (Feet)	Pipe Diameter (Inches)					Perforation Spacing (Feet)	Pipe Diameter (Inches)				
	1	1 1/4	1 1/2	2	3		1	1 1/4	1 1/2	2	3
2	10	13	18	30	60	2	11	16	21	34	68
2 1/2	8	12	16	28	54	2 1/2	10	14	20	32	64
3	8	12	16	25	52	3	9	14	19	30	60
3/16 Inch Perforations						1/8 Inch Perforations					
Perforation Spacing (Feet)	Pipe Diameter (Inches)					Perforation Spacing (Feet)	Pipe Diameter (Inches)				
	1	1 1/4	1 1/2	2	3		1	1 1/4	1 1/2	2	3
2	12	18	26	46	87	2	21	33	44	74	149
2 1/2	12	17	24	40	80	2 1/2	20	30	41	69	135
3	12	16	22	37	75	3	20	29	38	64	128

9. Total Number of Perforations equals the Number of Perforations per Lateral multiplied by the Number of Perforated Laterals.

$\text{ } \boxed{13} \text{ } \text{Perf. Per Lat.} \times \text{ } \boxed{3} \text{ } \text{Number of Perf. Lat.} = \text{ } \boxed{39} \text{ } \text{Total Number of Perf.}$

10. Select Type of Manifold Connection (End or Center): End Center

11. Select Lateral Diameter (See Table): in



OSTP Pressure Distribution Design Worksheet



12. Calculate the *Square Feet per Perforation*. Recommended value is 4-11 ft² per perforation.

Does not apply to At-Grades

a. *Bed Area* = Bed Width (ft) X Bed Length (ft)

10 ft X 38 ft = 380 ft²

b. *Square Foot per Perforation* = *Bed Area* divided by the *Total Number of Perforations*.

380 ft² ÷ 39 perforations = 9.7 ft²/perforations

13. Select *Minimum Average Head*: 1.0 ft

14. Select *Perforation Discharge* (GPM) based on Table: 0.74 GPM per Perforation

15. Determine required *Flow Rate* by multiplying the *Total Number of Perfs.* by the *Perforation Discharge*.

39 Perfs X 0.74 GPM per Perforation = 29 GPM

16. *Volume of Liquid Per Foot of Distribution Piping* (Table II): 0.170 Gallons/ft

17. *Volume of Distribution Piping* =

= [Number of Perforated Laterals X Length of Laterals X (Volume of Liquid Per Foot of Distribution Piping)]

3 X 36 ft X 0.170 gal/ft = 18.4 Gallons

18. *Minimum Delivered Volume* = *Volume of Distribution Piping* X 4

18.4 gals X 4 = 73.4 Gallons

Pipe Diameter (inches)	Liquid Per Foot (Gallons)
1	0.045
1.25	0.078
1.5	0.110
2	0.170
3	0.380
4	0.661

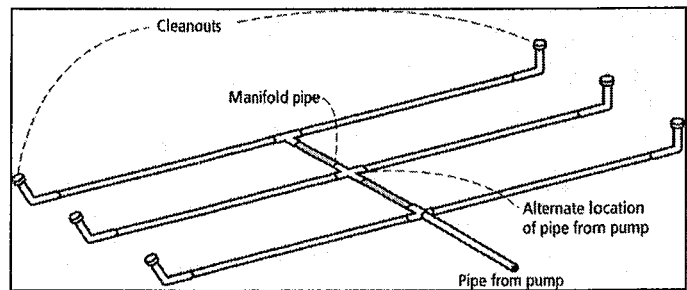
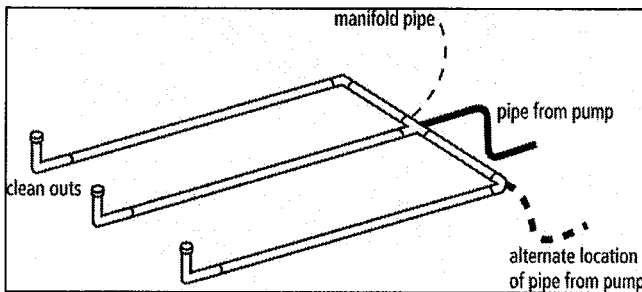

Comments/Special Design Considerations:

Blank area for comments and special design considerations.



OSTP Basic Pump Selection Design Worksheet



1. PUMP CAPACITY Project ID: _____

Pumping to Gravity or Pressure Distribution: Gravity Pressure Selection required

1. If pumping to gravity enter the gallon per minute of the pump: GPM (10 - 45 gpm)

2. If pumping to a pressurized distribution system: GPM

3. Enter pump description:

2. HEAD REQUIREMENTS

A. Elevation Difference ft between pump and point of discharge:

B. Distribution Head Loss: ft

C. Additional Head Loss: ft (due to special equipment, etc.)

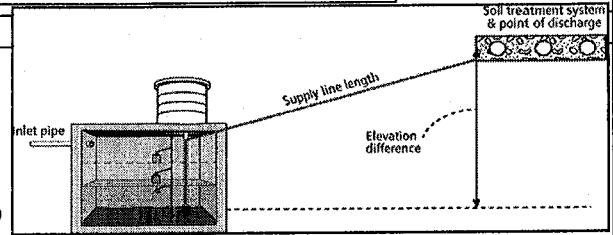

Distribution Head Loss	
Gravity Distribution = 0ft	
Pressure Distribution based on Minimum Average Head Value on Pressure Distribution Worksheet:	
Minimum Average Head	Distribution Head Loss
1ft	5ft
2ft	6ft
5ft	10ft

Table I. Friction Loss in Plastic Pipe per 100ft

Flow Rate (GPM)	Pipe Diameter (inches)			
	1	1.25	1.5	2
10	9.1	3.1	1.3	0.3
12	12.8	4.3	1.8	0.4
14	17.0	5.7	2.4	0.6
16	21.8	7.3	3.0	0.7
18		9.1	3.8	0.9
20		11.1	4.6	1.1
25		16.8	6.9	1.7
30		23.5	9.7	2.4
35			12.9	3.2
40			16.5	4.1
45			20.5	5.0
50				6.1
55				7.3
60				8.6
65				10.0
70				11.4
75				13.0
85				16.4
95				20.1

D. 1. Supply Pipe Diameter: in

2. Supply Pipe Length: ft

E. Friction Loss in Plastic Pipe per 100ft from Table I:

Friction Loss = ft per 100ft of pipe

F. Determine *Equivalent Pipe Length* from pump discharge to soil dispersal area discharge point. Estimate by adding 25% to supply pipe length for fitting loss. *Supply Pipe Length (D.2) X 1.25 = Equivalent Pipe Length*

ft X 1.25 = ft

G. Calculate *Supply Friction Loss* by multiplying *Friction Loss Per 100ft* (Line E) by the *Equivalent Pipe Length* (Line F) and divide by 100.

Supply Friction Loss = ft per 100ft X ft ÷ 100 = ft

H. *Total Head* requirement is the sum of the *Elevation Difference* (Line A), the *Distribution Head Loss* (Line B), *Additional Head Loss* (Line C), and the *Supply Friction Loss* (Line G)

ft + ft + ft + ft = ft

3. PUMP SELECTION

A pump must be selected to deliver at least **29.0** GPM (Line 1 or Line 2) with at least **14.1** feet of total head.

Comments:



DETERMINE TANK CAPACITY AND DIMENSIONS Project ID: v 05.13.14

1. A. Design Flow (Design Sum. 1A): 450 GPD
- B. Min. required pump tank capacity: 500 Gal C. Recommended pump tank capacity: 500 Gal
- D. Pump tank description: Demand to Pressure

MEASURED TANK CAPACITY (existing tanks):

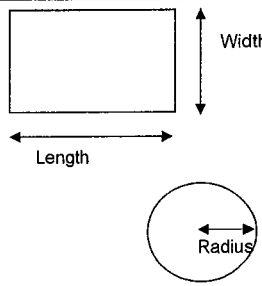
2. A. Rectangle area = Length (L) X Width (W)
 ft X ft = ft²
- B. Circle area = 3.14r² (3.14 X radius X radius)
 3.14 X ² ft = ft²
- C. Calculate Gallons Per Inch. Multiply the area from 1.A or 1.B, by 7.5 to determine the gallons per foot the tank holds and divide by 12 to calculate the gallons per inch.
 ft² X 7.5 gal/ft³ ÷ 12 in/ft = Gallons per inch
- D. Calculate Total Tank Volume
 Depth from bottom of inlet pipe to tank bottom: in
 Total Tank Volume = Depth from bottom of inlet pipe (Line 4.A) X Gallons/Inch (Line 2)
 in X 11.7 Gallons Per Inch = Gallons
- 

MANUFACTURER'S SPECIFIED TANK CAPACITY (when available):

3. A. Tank Manufacturer: brown
- B. Tank Model: 1500 2-C
- C. Capacity from manufacturer: 504 Gallons
- D. Gallons per inch from manufacturer: 11.7 Gallons per inch
- E. Liquid depth of tank from manufacturer: 43.0 inches

Note: Design calculations are based on this specific tank. Substituting a different tank model will change the pump float or timer settings. Contact designer if changes are necessary.

DETERMINE DOSING VOLUME

4. Calculate Volume to Cover Pump (The inlet of the pump must be at least 4-inches from the bottom of the pump tank & 2 inches of water covering the pump is recommended)
 (Pump and block height + 2 inches) X Gallons Per Inch (2C or 3E)
 (12 in + 2 inches) X 11.7 Gallons Per Inch = 164 Gallons
5. Minimum Delivered Volume = 4 X Volume of Distribution Piping:
 - Line 17 of the Pressure Distribution or Line 11 of Non-level 73 Gallons (minimum dose)
6. Calculate Maximum Pumpout Volume (25% of Design Flow)
 Design Flow: 450 GPD X 0.25 = 113 Gallons (maximum dose)

7. Select a pumpout volume that meets both Minimum and Maximum: 100 Gallons

8. Calculate Doses Per Day = Design Flow ÷ Delivered Volume
450 gpd ÷ 100 gal = 4 Doses

9. Calculate Drainback:
- A. Diameter of Supply Pipe = 2 inches
- B. Length of Supply Pipe = 40 feet
- C. Volume of Liquid Per Lineal Foot of Pipe = 0.170 Gallons/ft
- D. Drainback = Length of Supply Pipe X Volume of Liquid Per Lineal Foot of Pipe
40 ft X 0.170 gal/ft = 6.8 Gallons

10. Total Dosing Volume = Delivered Volume plus Drainback
100 gal + 6.8 gal = 107 Gallons

11. Minimum Alarm Volume = Depth of alarm (2 or 3 inches) X gallons per inch of tank
2 in X 11.7 gal/in = 23.4 Gallons

Volume of Liquid in Pipe	
Pipe Diameter (inches)	Liquid Per Foot (Gallons)
1	0.045
1.25	0.078
1.5	0.110
2	0.170
3	0.380
4	0.661



TIMER or DEMAND FLOAT SETTINGS

Select Timer or Demand Dosing:

Timer

Demand Dose

A. Timer Settings

12. Required Flow Rate:

A. From Design (Line 12 of Pressure Distribution or Line 10 of Non-Level*):

GPM

B. Or calculated: $GPM = \text{Change in Depth (in)} \times \text{Gallons Per Inch} / \text{Time Interval in Minutes}$

in X gal/in ÷ min = GPM

**Note: This value must be adjusted after installation based on pump calibration.*

13. Flow Rate from Line 12.A or 12.B above:

GPM

14. Calculate **TIMER ON** setting:

Total Dosing Volume/GPM

gal ÷ gpm = Minutes ON

15. Calculate **TIMER OFF** setting:

Minutes Per Day (1440)/Doses Per Day - Minutes On

1440 min ÷ doses/day - min = Minutes OFF

16. Pump Off Float - Measuring from bottom of tank:

Distance to set Pump Off Float=Gallons to Cover Pump / Gallons Per Inch:

gal ÷ gal/in = Inches

17. Alarm Float - Measuring from bottom of tank:

Distance to set Alarm Float = Tank Depth(4A) X 90% of Tank Depth

in X 0.90 = in

B. DEMAND DOSE FLOAT SETTINGS

18. Calculate *Float Separation Distance* using *Dosing Volume*.

Total Dosing Volume /Gallons Per Inch

gal ÷ gal/in = Inches

19. Measuring from bottom of tank:

A. *Distance to set Pump Off Float* = Pump + block height + 2 inches

in + in = Inches

B. *Distance to set Pump On Float*=Distance to Set Pump-Off Float + Float Separation Distance

in + in = Inches

C. *Distance to set Alarm Float* = Distance to set Pump-On Float + Alarm Depth (2-3 inches)

in + in = Inches

FLOAT SETTINGS

DEMAND DOSING

TIMED DOSING

Inches for Dose: in

Alarm Depth in

Pump On in

Pump Off in

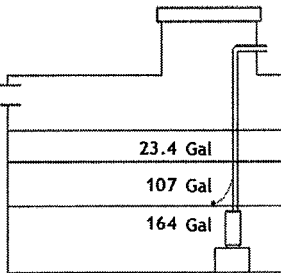

Alarm Depth in

Pump Off in

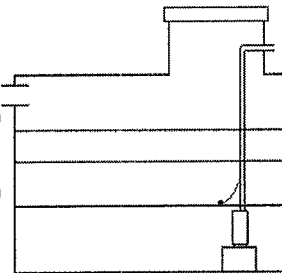

Soil Map—Becker County, Minnesota

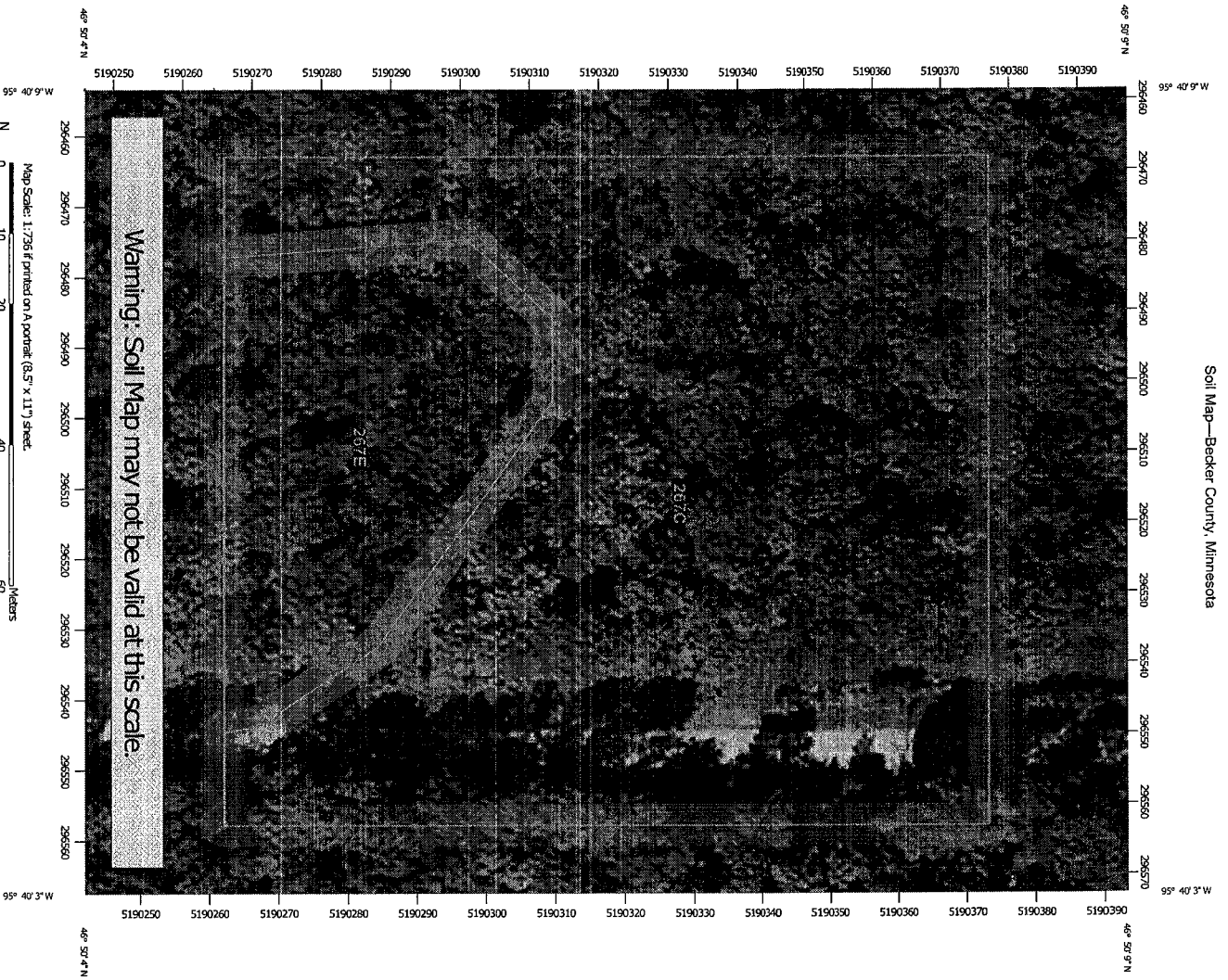











































Map Scale: 1:736 if printed on A portrait (8.5" x 11") sheet.



Map projection: Web Mercator Corner coordinates: WGS84 Edge tics: UTM Zone 15N WGS84

MAP LEGEND

	Area of Interest (AOI)		Spill Area
	Area of Interest (AOI)		Stony Spot
	Soils		Very Stony Spot
	Soil Map Unit Polygons		Wet Spot
	Soil Map Unit Lines		Other
	Soil Map Unit Points		Special Line Features
	Special Point Features		Water Features
	Blowout		Streams and Canals
	Borrow Pit		Transportation
	Clay Spot		Rails
	Closed Depression		Interstate Highways
	Gravel Pit		US Routes
	Gravelly Spot		Major Roads
	Landfill		Local Roads
	Lava Flow		Background
	Marsh or swamp		Aerial Photography
	Mine or Quarry		
	Miscellaneous Water		
	Perennial Water		
	Rock Outcrop		
	Saline Spot		
	Sandy Spot		
	Severely Eroded Spot		
	Sinkhole		
	Slide or Slip		
	Sodic Spot		

MAP INFORMATION

The soil surveys that comprise your AOI were mapped at 1:20,000.

Warning: Soil Map may not be valid at this scale.

Enlargement of maps beyond the scale of mapping can cause misunderstanding of the detail of mapping and accuracy of soil line placement. The maps do not show the small areas of contrasting soils that could have been shown at a more detailed scale.

Please rely on the bar scale on each map sheet for map measurements.

Source of Map: Natural Resources Conservation Service
 Web Soil Survey URL: <http://websoilsurvey.nrcs.usda.gov>
 Coordinate System: Web Mercator (EPSG:3857)

Maps from the Web Soil Survey are based on the Web Mercator projection, which preserves direction and shape but distorts distance and area. A projection that preserves area, such as the Albers equal-area conic projection, should be used if more accurate calculations of distance or area are required.

This product is generated from the USDA-NRCS certified data as of the version date(s) listed below.

Soil Survey Area: Becker County, Minnesota
 Survey Area Data: Version 11, Sep 18, 2015

Soil map units are labeled (as space allows) for map scales 1:50,000 or larger.

Date(s) aerial images were photographed: Data not available.

The orthophoto or other base map on which the soil lines were compiled and digitized probably differs from the background imagery displayed on these maps. As a result, some minor shifting of map unit boundaries may be evident.

Map Unit Legend

Becker County, Minnesota (MN005)			
Map Unit Symbol	Map Unit Name	Acres in AOI	Percent of AOI
267C	Snellman sandy loam, 8 to 15 percent slopes	2.0	77.7%
267E	Snellman sandy loam, 15 to 30 percent slopes	0.6	22.3%
Totals for Area of Interest		2.6	100.0%

Becker County, Minnesota

267C—Snellman sandy loam, 8 to 15 percent slopes

Map Unit Setting

National map unit symbol: 2V01k

Elevation: 590 to 2,030 feet

Mean annual precipitation: 24 to 33 inches

Mean annual air temperature: 37 to 48 degrees F

Frost-free period: 110 to 170 days

Farmland classification: Farmland of statewide importance

Map Unit Composition

Snellman, rolling, and similar soils: 85 percent

Minor components: 15 percent

Estimates are based on observations, descriptions, and transects of the

mapunit.

Description of Snellman, Rolling

Setting

Landform: Moraines

Landform position (two-dimensional): Summit, shoulder

Landform position (three-dimensional): Side slope

Down-slope shape: Linear

Across-slope shape: Convex

Parent material: Till

Typical profile

A - 0 to 2 inches: sandy loam

E - 2 to 16 inches: loamy sand

Bt - 16 to 31 inches: sandy clay loam

C - 31 to 79 inches: sandy loam

Properties and qualities

Slope: 8 to 15 percent

Depth to restrictive feature: More than 80 inches

Natural drainage class: Well drained

Capacity of the most limiting layer to transmit water (Ksat):

Moderately high to high (0.60 to 2.00 in/hr)

Depth to water table: More than 80 inches

Frequency of flooding: None

Frequency of ponding: None

Calcium carbonate, maximum in profile: 15 percent

Salinity, maximum in profile: Nonsaline to very slightly saline (0.0 to

2.0 mmhos/cm)

Available water storage in profile: Moderate (about 7.5 inches)

Interpretive groups

Land capability classification (irrigated): None specified

Land capability classification (nonirrigated): 3e

Hydrologic Soil Group: B

Minor Components

Other vegetative classification: Sloping: Fine Texture
(G057XN023MN)
Hydric soil rating: No

Wykeham

Percent of map unit: 5 percent
Landform: Moraines
Landform position (two-dimensional): Backslope
Landform position (three-dimensional): Side slope
Down-slope shape: Convex
Across-slope shape: Convex
Other vegetative classification: Sloping Upland, Acid
(G057XN006MN)
Hydric soil rating: No

Egflake

Percent of map unit: 3 percent
Landform: Moraines
Landform position (two-dimensional): Footslope
Landform position (three-dimensional): Side slope
Down-slope shape: Linear
Across-slope shape: Concave
Other vegetative classification: Level Swale, Neutral
(G057XN001MN)
Hydric soil rating: Yes

Leaflake

Percent of map unit: 3 percent
Landform: Moraines
Landform position (two-dimensional): Summit, shoulder
Landform position (three-dimensional): Side slope
Down-slope shape: Linear
Across-slope shape: Convex
Other vegetative classification: Sloping Upland, Neutral
(G057XN002MN)
Hydric soil rating: No

Cathro, frequently ponded

Percent of map unit: 2 percent
Landform: Depressions on moraines
Landform position (two-dimensional): Toeslope
Landform position (three-dimensional): Dip
Down-slope shape: Concave
Across-slope shape: Concave
Other vegetative classification: Not Suited (G057XN024MN)
Hydric soil rating: Yes

Snellman

Percent of map unit: 2 percent
Landform: Moraines
Landform position (two-dimensional): Summit, shoulder
Landform position (three-dimensional): Side slope



Soil Survey Area: Becker County, Minnesota
Survey Area Data: Version 11, Sep 18, 2015

Data Source Information

Down-slope shape: Linear
Across-slope shape: Convex
Other vegetative classification: Steep; Fine Texture
(G057XN017MN)
Hydric soil rating: No

***** FOR OFFICE USE ONLY *****

Application Approved by: Laurie Stoll Date: 11/21/16
 Amount Paid \$ 750.00 Receipt Number 224044636536 Permit Number _____

NOTES: _____

Tank only - mound installed next spring.

INSPECTION REPORT

Home Information

Does the structure contain any of the following elements?

Garbage disposer Yes No Dishwasher Yes No
 Grinder pump Yes No Lift pump in basement Yes No
 Effluent screen installed? Yes No Effluent screen manufacturer _____

Alarm required? Yes No Alarm Type Electric Alarm manufacturer _____

Lift pump in system? Yes No Pump manufacturer 29 gpm

Number of bedrooms 3

Component Information

Tank size 1500 2/c Tank manufacturer Brown
 Drainfield size 380 sq ft Medium manufacturer 10' x 38' mound
 Drainfield medium _____
 Drainfield medium size/depth _____

Soil Verification

Vertical separation verified for Boring #1 on _____ Depth +36"
 Vertical separation verified for Boring #2 on _____ Depth _____
 Vertical separation verified for Boring #3 on _____ Depth _____

Setback Verification

	TANK	DRAINFIELD
Distance to Well	<u>+50</u>	<u>+50</u>
Distance to Building	<u>+10</u>	<u>+20</u>
Distance to Property Line	<u>+10</u>	<u>+10</u>
Distance to OHW of Lake	<u>-</u>	<u>-</u>
Distance to Pressure Line	<u>+50</u>	<u>+50</u>
Distance to Wetland/Protected Water	<u>+50</u>	<u>+50</u>

Date System Installed 6/21/16 Installer Tony Stayer, Exc Inspector Laurie Stoll

CERTIFICATE OF COMPLIANCE

() Certificate Is Hereby Denied
 (X) Certificate is Hereby Granted Based upon the Application, addendum from, plans, specifications and all other supporting data.
 With property maintenance, this system can be expected to function satisfactory, however, this is not a guarantee.

Signature Laurie Stoll Title ISTS Inspector Date 6/21/17

(Certificate of Compliance is not valid unless signed by a Registered Qualified Employee)